

ANGLE FRAME, PEDESTRIAN LOADING, SINGLE DOOR - ALUMINUM

This drawing is the sole property of U.S.F. Fabrication, Inc. and is for illustrative purposes only.

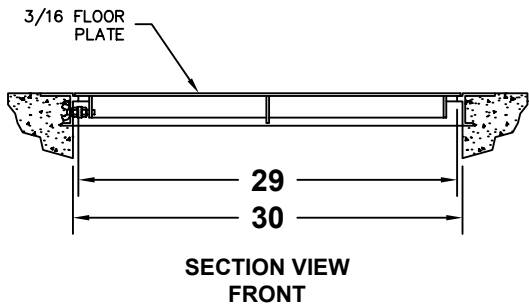
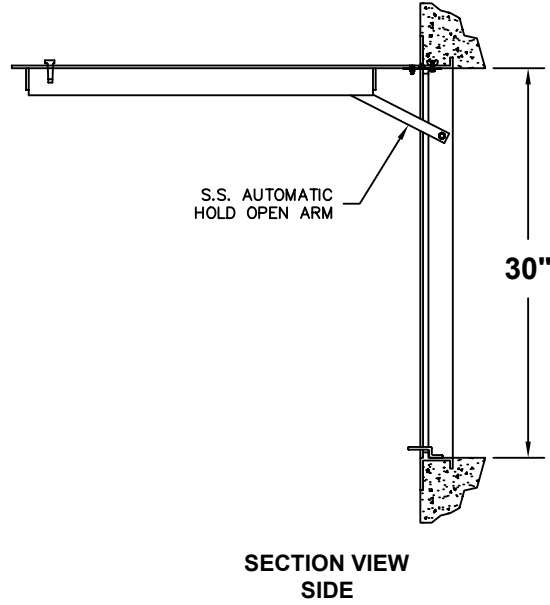
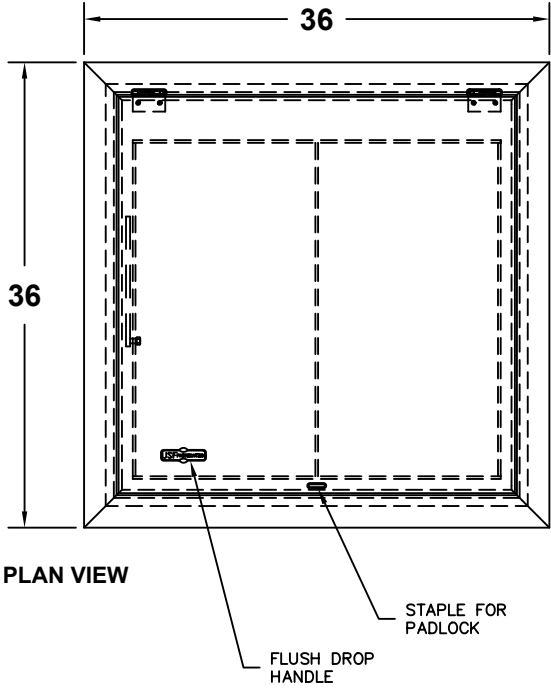

VCP DESIGNATION: 30X30 APS150 ALUMINUM HATCH

- NOTES:**
- 1- MATERIAL: ALUMINUM
 - 2- LOADING: 150 LBS. PER SQ. FT.
 - 3- 316 STAINLESS STEEL BOLTS HINGES AND HOLD OPEN ARM

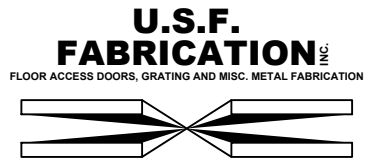

APS150 ALUMINUM		
FROM: WEB ID: 7	QUOTE# STANDARD	DATE: 8/28/2002